

# MONITORING UNITS

**For minimising the danger of overheating of heatseal bands  
in connection with Ropex temperature controllers  
during impulse heatsealing of foils**



**MSW**

**RESM**



## TABLE OF CONTENTS

<b>1</b>	<b>INTRODUCTION</b>	<b>8</b>	<b>MONITORING WITH THE RESM</b>
<b>2</b>	<b>PROBLEM DESCRIPTION</b>	<b>8.1</b>	Alarm Evaluation
<b>3</b>	<b>SOURCES OF FAULTS</b>	<b>8.2</b>	Wiring Diagram
<b>4</b>	<b>MEASURES FOR REDUCING THE DANGER OF OVERHEATING</b>	<b>8.3</b>	Display and Operating Elements
<b>4.1</b>	Preventive Measures	<b>8.4</b>	Operating Instructions for the RESM
<b>4.2</b>	Additional Measures	<b>8.5</b>	Functional Check of the RESM
<b>5</b>	<b>FAULT TYPES AND THEIR RECOGNITION</b>	<b>8.6</b>	RESM Dimensions
<b>6</b>	<b>PREREQUISITES</b>	<b>9</b>	<b>MONITORING WITH THE MSW AND THE RESM</b>
<b>7</b>	<b>MONITORING WITH THE MSW</b>	<b>9.1</b>	Functional Check
<b>7.1</b>	Method of Operation	<b>9.2</b>	Examples
<b>7.2</b>	MSW in the General Situation	<b>10</b>	<b>TYPE IDENTIFICATION</b>
<b>7.3</b>	MSW in a Series Circuit	<b>10.1</b>	MSW
<b>7.4</b>	Connection Instructions	<b>10.2</b>	RESM
<b>7.5</b>	Alarm Evaluation	<b>11</b>	<b>REMAINING RISK</b>
<b>7.6</b>	Functional Check		
<b>7.7</b>	MSW Dimensions		

Exclusive Sales and Service :  
[www.tossheatseal.com](http://www.tossheatseal.com)

## 1

## INTRODUCTION

The following explanations first cover the reasons which can lead to undesired overheating during thermal control of heatseal bands based on the resistance principle.

Following this, measures to minimise the danger of overheating are described.

## 2

## PROBLEM DESCRIPTION

During temperature control of heatseal bands based on the resistance technique the heatseal band acts both as a heat generator and a temperature sensor at the same time. Via its alloy-specific temperature coefficient of resistance  $T_K$  the heatseal band exhibits a clearly assigned resistance value for each temperature.

As a result of external effects such as partial short circuits, contacting problems, cross-section changes etc., this assignment can be destroyed, i.e. the controller "sees" an incorrect resistance and reacts to it, depending on the direction of the change, with a reduction or an increase of the heating current to "follow" this incorrect set point. Such faults can lead to considerable deviations of temperature from the set point.

While an increase in the measured resistance (cross-section reduction due to physical damage, disconnecting or corroding terminal elements, copper-plating wear) leads to a harmless reduction of the real heatseal band temperature, a partial short circuit (earth fault, conductive foreign bodies, contact between two heatseal bands) results from time to time in a considerable temperature increase of the still active heatseal band lengths which can very quickly lead to dangerous levels in terms of a danger of fire or explosion.

Already here it can be seen that, depending on the construction, design and cabling of heatsealing tools and depending on the interconnection of heatseal bands, there can be a variety of reasons for faults.

## 3

## SOURCES OF FAULTS

If one analyses the components involved in the entire control loop in respect of possible fault sources which are relevant in the sense of dangerous overheating, a variety of causes result such as e.g.:

- contact between two heatseal bands wired in series
- earth fault
- partial short circuit
- non-copper-plated heatseal band ends
- unsuitable heatseal band alloy ( $T_K = 0$  or too low)
- defects in the measuring circuit of the controller electronics
- defect in the power element of the controller, e.g. Triac remains conductive without an ignition signal
- short circuit in the external wiring such that the Triac is bridged
- defective current transformer
- short circuit or break in the measurement leads for current or voltage ( $U_R$ )
- operating errors, etc.

Resistance changes which occur abruptly and which are so large that they fall outside the working range (below zero - above 300°C) can be recognised and reported by the controller.

On the other hand smaller resistance jumps or "creeping" changes can as a matter of principle not be recognised as a fault and lead to the temperature deviations already described.

Some of the faults listed here can be covered by standard RES controllers with an alarm function. Some others are detected by the MSW and RESM units described here.

Despite the use of both these monitoring units a few faults remain with the current technological state of the art.  
(➔ Remaining Risk)

## 4

### MEASURES FOR REDUCING THE DANGER OF OVERHEATING

#### 4.1

#### Preventive Measures

As in mechanical engineering in general it is also true here that the safety aspects must be considered starting with construction of the heatsealing system.

In this way some faults can not occur at all.

It is not possible to provide an instruction manual for construction of heatsealing tools; only some key words as reminders:

##### Bar end blocks (the heatseal band's expansion joint)

- electrically insulated on both sides
- tightened at both ends
- sufficient spring strength, unrestricted run
- tight heatseal band clamping
- tight power connection
- do not pass current through moving parts (pin-ties or similar)
- careful attention to insulation

##### Heatseal bands

- Use heatseal bands with the specified  $T_K$ .
- Copper-plate the ends up to at least 10 mm into the heatseal bar.
- Where a danger of corrosion exists protect the copper plating with a nickel or gold layer.

##### Bars

- flat, warp-free bars
- careful attention to the heatseal band insulation

##### Electrical installation

- use adequate cable cross-sections
- minimise cable lengths
- avoid plug-in connections
- measuring leads with their own connection on the bar end blocks

etc.

(➔ "General Installation Advice") in every RESISTRON description

#### 4.2

#### Additional Measures

For further improvement of the operating safety of such control circuits, in particular in respect of the avoidance of dangerous overheating, **ROPEX** has developed monitoring units which, depending on the desired safety level, can be integrated, individually or combined, into circuits operated with RESISTRON controllers.

Taking into consideration the prerequisites listed in Section 7, existing control circuits can also be retrofitted without problems.

Two monitoring units are available.

The fault current monitor **"MSW"**

The redundant measuring system **"RESM"**

The types of faults which each unit or the controller (with alarm function) recognises can be seen in the following table.

## 5 FAULT TYPES AND THEIR RECOGNITION (Double faults are not covered)

Table 1 Fault types	Fault recognition using			
	RESISTRON controller "series 200" with ALARM function	RESISTRON controller "series 400" with ALARM function	Fault current monitoring MSW	Redundant measuring RESM
Heatseal band break	Yes	Yes	No	Yes
Measuring leads for $I_R$ and $U_R$ (break or short circuit)	Yes	Yes	No	Yes
Contact between to heatseal bands (series wiring)	No	Possibly 2)	Yes	No
Partial short circuit over heatseal band	No	Possibly 2)	No	No
Earth fault	No	No	Yes	No
Zero-point suppression due to incorrect calibration	Yes	Yes	No	Yes
Hardware defect in the controller	No	No	No	Yes
Triac conductiv or bridged	Possibly 1)	Yes	No	Yes
Current transformer defective	No	No	No	Yes
Heatseal band with to low or no $T_K$ 3)	No	No	No	No

1) not until 350°C is exceeded and with an intact measuring circuit  
3) see also "Remaining Risk"

2) when resistance of the heatsealing band changes more than 10%

## 6 PREREQUISITES for the USE of the MONITORING UNITS



To avoid safety gaps the following prerequisites must be met when using these components:

- a.) RESISTRON controller of the "200" or "400" series **with** ALARM function
  - **indispensable** with use of the **RESM** unit
  - recommended when using the **MSW** unit in order that the fault can be reported and corrected.
- b.) The heatseal band used **must** be adequately **copper-plated** from its current input point up to the heatsealing zone on the heatseal bar in order to prevent overheating of the thermally non-loaded zones by the working current. With interconnected heatseal bands all heatseal bands must fulfil this condition.
- c.) An additional fundamental prerequisite must be mentioned here since it is extremely important:

The heatseal band used must have a minimum temperature coefficient of  $T_K \geq +10 \times 10^{-4} K^{-1} = 1000 \text{ ppm} \times K^{-1}$

### CAUTION

The use of incorrect alloys with too low a  $T_K$  leads to excessive temperatures and sometimes also to a "racing" temperature up to melting of the heatseal band.

This type of fault can **not** be recognised by **any** of the monitoring components described here!

(➔ Remaining Risk)

A heatseal band with a higher  $T_K$  than specified above has as a result a lower temperature than that indicated by the controller. This fault behaviour leads in the harmless direction.

Using appropriate identification markings, connection shapes, lengths etc., it must be ensured that the original heatseal bands can not be mixed up.

## USE of the MONITORING UNITS MSW and RESM

**Symbols used:**

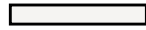

**Heatseal bar**  
(Heatseal carrier)

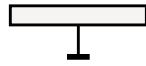

**Heatseal bar electrically earthed**  
The earth connection may not be made via moving parts such as guides, piston rods, curves, levers etc.



**Heatseal band**



**Foil**

### 7 MONITORING with the MSW

There are two cases (see Table 1) which necessitate the use of this monitoring module:

**A.) With a heatseal band earth fault**

Here once again a differentiation must be made between 2 cases:

**A.1) Secondary circuit **not earthed**:**

Contact between one point of the heatseal band and the earth does not yet cause a dangerous situation. Only when an earth fault occurs at **two** points B - B' does this lead to overheating of the sections A - B and A' - B'.

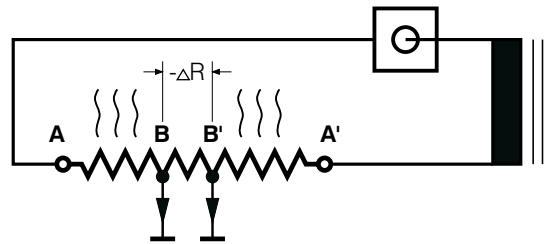

**A.2) Secondary circuit **earthed**:**

This measure can be necessary for reasons other than those considered here, e.g. for safety reasons (transformer could break down from the primary to the secondary), or due to a necessary high secondary voltage with star point, or due to static charging of the foil which could lead to destruction of the controller. In this constellation contact between **one** point of the heatseal band and the earth is sufficient to cause overheating.

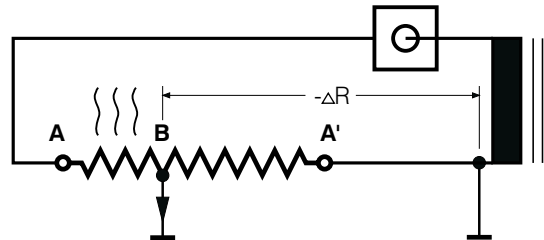

**B.) With contact between two opposite-lying heatseal bands wired in series:**

If the foil is to be heated on both sides, parallel wiring of the heatseal bands is to be given preference since contact between the bands is harmless due to the equal potential.

Series wiring has cabling advantages: The main current leads are shorter, lie closer together and the course of the measuring lead  $U_a$  is better.

The danger of overheating due to mutual contact is, however, relatively high since the insulating Teflon layer is subject to wear.

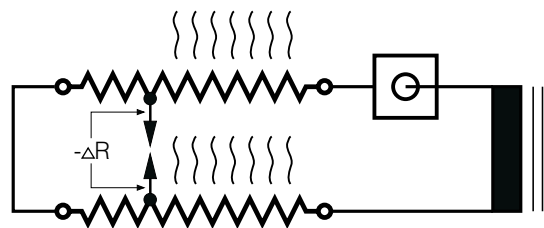

All three cases mentioned, A1), A2) und B), result from insulation faults below or above the heatseal band. These situations can be recognised by earthing the secondary circuit and measuring the earth current  $I_{GND}$  with the current detector of the MSW unit.

## 7.1 Method of Operation of the MSW

The arising earth current  $I_{GND}$  is recognised by the current detector of the monitoring current transformer and is reported via the existing measuring transformer lead  $I_R$  to the controller which then reports an alarm. Although the MSW unit contains active components, no voltage supply is needed.

## 7.2 Monitoring with the MSW with Any Circuit Type Without Mutual Danger of Contact Between the Heatseal Band

### CIRCUIT DIAGRAM:

The MSW recognises an earth fault on the heatseal band or at any position on the secondary circuit. The earth connection of the secondary circuit must be done directly at the impulse-transformer. The heatseal band carrier (e.g. heatseal bar) **must be earthed**.

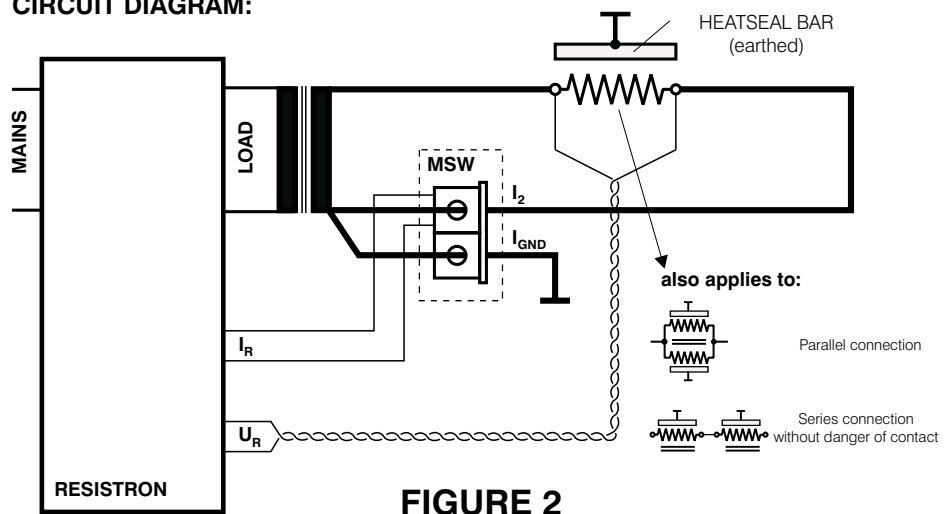

## 7.3 Monitoring with the MSW with Series Connection With Danger of Contact Between the Heatseal Bands

### CIRCUIT DIAGRAM:

The MSW recognises all earth faults as well as mutual contact between the heatseal bands. With this type of connection the measuring transformer  $I_2$  must be fed into the connecting lead of both heatseal bands. The earth connection via the current transformer  $I_{GND}$  must be connected also at the leads between the heatsealing bands.

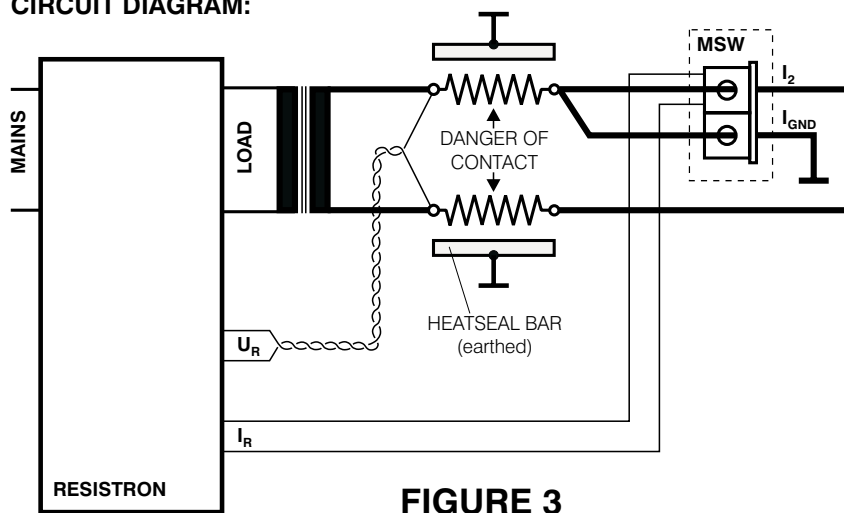

## 7.4 Connection Instructions for the Cabling

- For the earthing of the secondary circuit (via the current detector  $I_{GND}$ ) a cable cross-section of approx. 30% of the cross-section of the main power cable ( $I_2$ ) is sufficient..
- The same applies for the earthing of the heatseal bar. This connection may not be made via moving parts such as guides, piston rods, curves, levers etc.
- The push-through direction of the cable through the current transformer is not important (for  $I_{GND}$  and  $I_2$ ). Ensure the same number of turns in both current transformers.

## 7.5 Alarm Evaluation

If only the MSW unit is used (not in connection with the RESM) no external switching mechanisms are necessary. A fault recognised by the MSW initiates the alarm in the RESISTRON controller. This locks its output and prevents possible overheating of the heatseal band.

(RESET → relevant controller description)

RESISTRON controllers at the "series 200" without an alarm function switch over to sampling mode as long as the MSW recognises a fault. The heatseal band is only fed with the sampling impulses. Overheating is also suppressed in this case. Controllers of the "series 400" don't generate sampling pulses when a fault occurred.

## 7.6 Functional Check of the MSW

1. Connect the RESISTRON controller and the MSW in accordance with the wiring diagram.
  2. Put the RESISTRON controller into operation ( → relevant controller description)
  3. Switch on the controller, heat up the heatseal band. Using a piece of cable provoke an earth fault on the heatseal band; no overheating may occur, the controller must enter the alarm mode or the sampling mode. Repeat the check at various points on the heatseal band and the secondary circuit.
- In the case of series connection in accordance with Figure 3 also connect both heatseal bands with a cable jumper.

## 7.7 MSW Dimensions

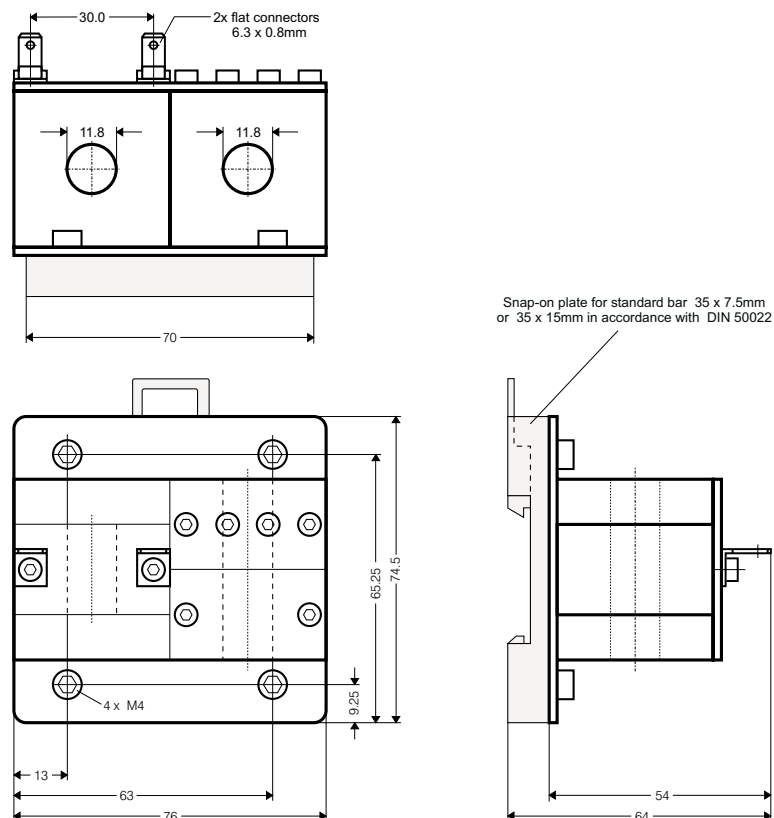

## 8 MONITORING with the Parallel Measuring System "RESM"

With a detailed connection analysis of the RES controllers a variety of hardware faults are conceivable which can lead to a dangerous state in the sense of heatseal bar overheating and which can not be recognised by the standard alarm function (see Table 1). Even when the probability of many hardware faults is relatively low, such failures can not be completely excluded.

**Monitoring of the complete controller including the current transformer can therefore only take place via a redundant measuring system, the RESM.**

The PREREQUISITES listed in Section 7 must also be observed here.

The RESM unit is connected to an existing RESISTRON control system (all RES controllers of the 200 series with an alarm function) and takes over the resistance measurement of the heatseal band including the temperature display in parallel mode with its own current transformer.

The RESM is connected in phase with the main controller to the mains. The measurement voltage  $U_r$  is for practical reasons taken from the main controller while the current transformer signal  $I_r$  is provided by a separate current transformer (Figure 4).

On the RESM there is an analogue display for the temperature with a zero-point setting trimmer which, in a similar manner as on the main controller, must be adjusted to the "Z" marking with a cold heatseal bar.

A variable limit monitors the maximum temperature and reports via a relay when this value is exceeded (fault case).

The number of turns and the coding of the DIP switch on the RESM and the main controller must be configured acc. the ROPEX application report.

### CIRCUIT DIAGRAM:

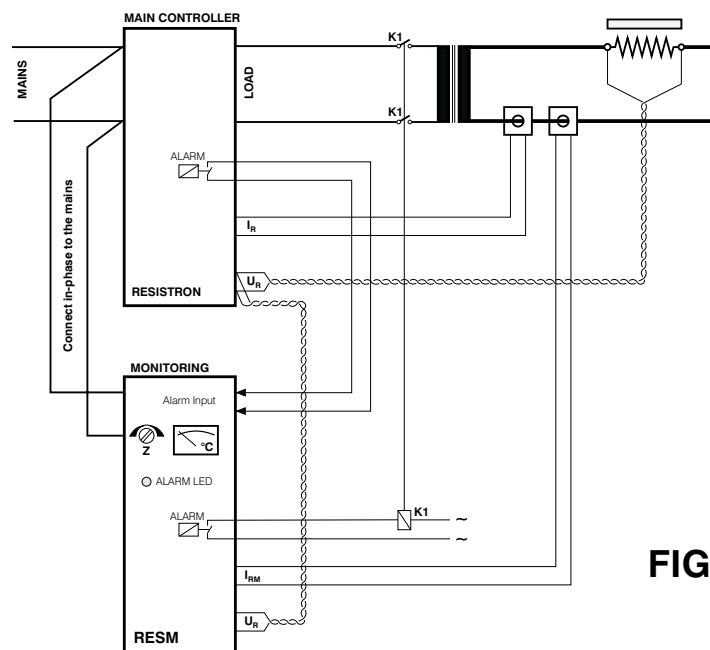

**FIGURE 4**

### 8.1 Alarm Evaluation

The alarm evaluation with the RESM takes place as shown in Figure 4. To be able to link the alarms the alarm signal of the main controller must be connected to the RESM. If any lead to the RESM module is missing this is recognised and also leads to an alarm (self-monitoring).

The external alarm evaluation (contactor K1) must ensure that in the case of a fault the load (transformer) is switched off bipolarly.

The fault is displayed on the main controller and on the RESM via a red LED.

The switching capacity of the contactor K1 must be adequately dimensioned for the application.

In the extreme case this capacity is equal to the maximum controller power: 25A/400V short-term.



## 8.2

### Wiring Diagram

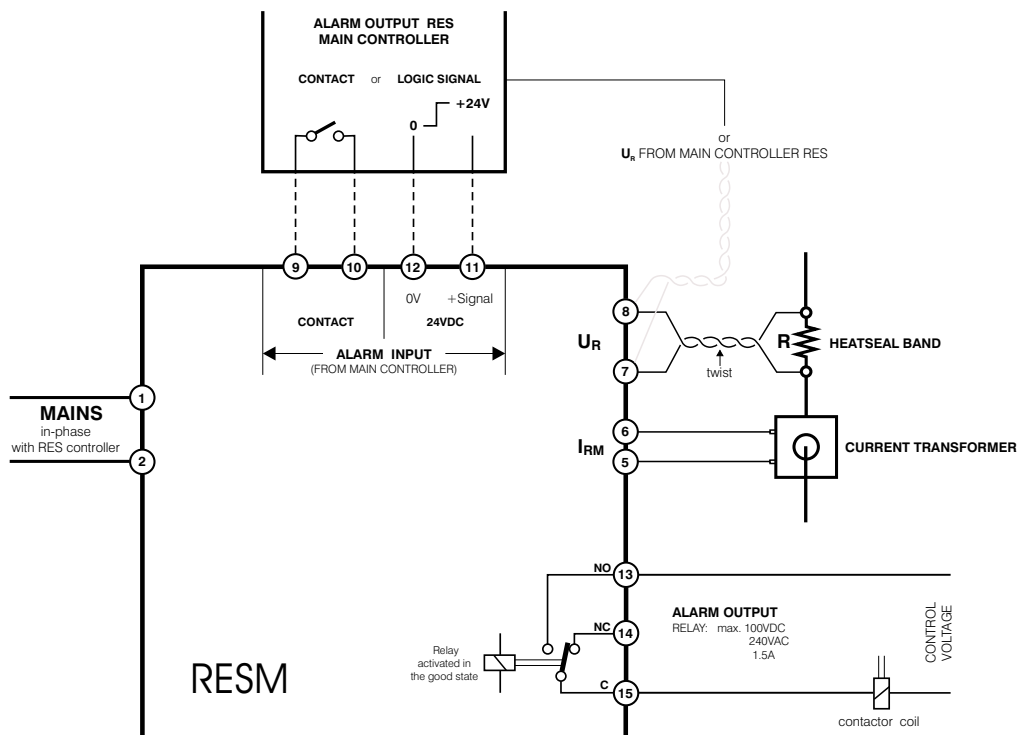

## 8.3

### Display and Operating Elements

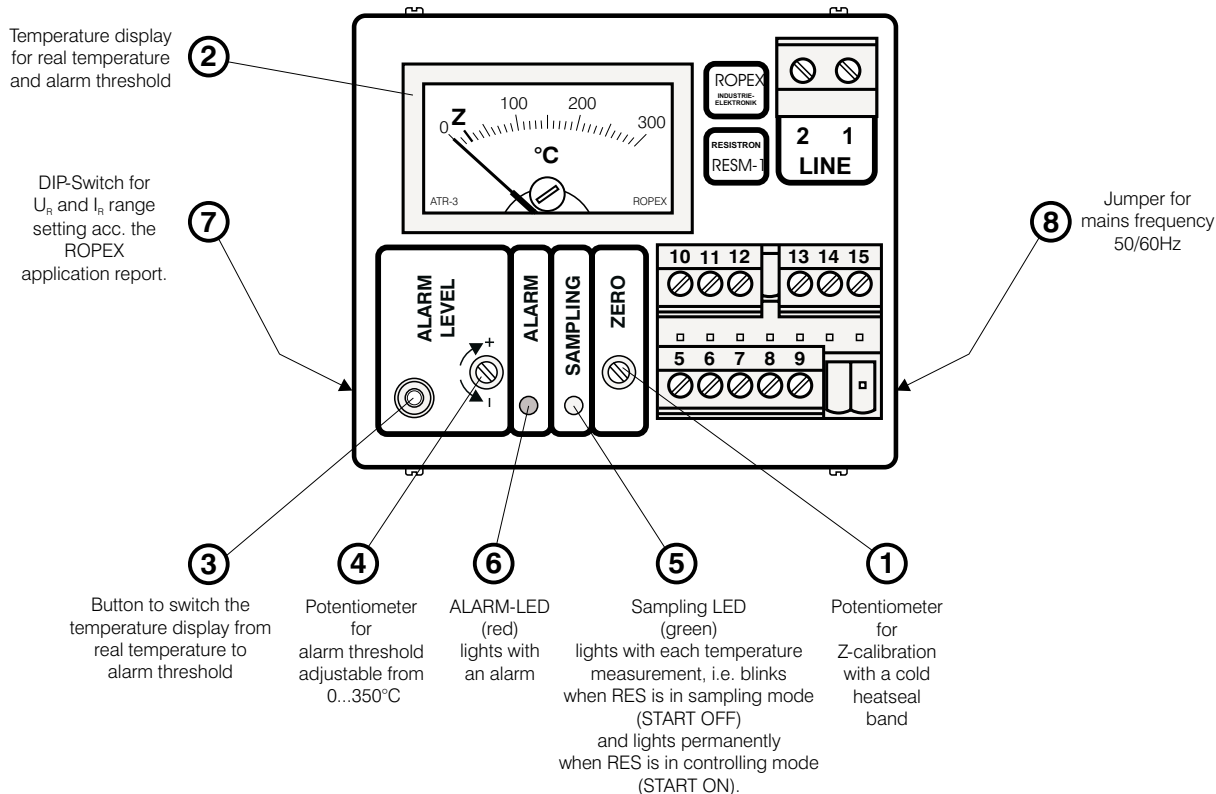

## 8.4 Operating Instructions for the RESM

**Prerequisite:** Main controller RES correctly connected, coded, calibrated and ready for use.  
(➔ relevant operating manual)

Check that the mains voltage and frequency match the specifications on the device type label.

Insert the jumper for the mains frequency into the appropriate position (50 **or** 60 Hz) at the side of the casing.

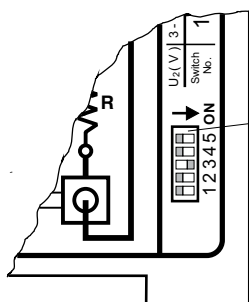
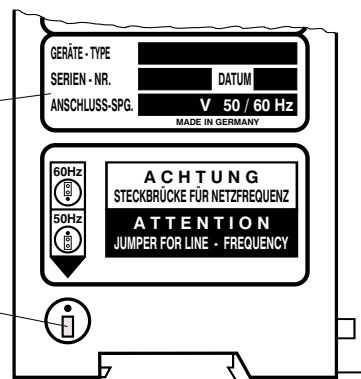

Set the position of the coding switch for selection of the current and voltage range acc. the ROPEX application report

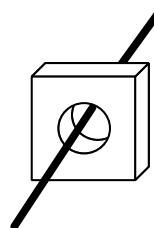

Same number of turns through the current transformer as on the current transformer of the main controller RES



Connect the device in accordance with the wiring diagram.  
Ensure that the mains connection of the RESM is in phase with the main controller.

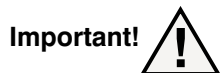

Ensure that there is not a start signal on the main controller.

Switch on the mains voltage. Always switch on the mains power for the RESM and RES at the same time. LED ⑤ (green) must blink. When using a controller of the "series 400" the additional data sheet must be noticed!

With the ZERO potentiometer ① set the pointer of the temperature display ② to the "Z" mark (= 20°C).



**This calibration may only be performed with a cold heatseal band.**

The temperature display of the RESM must always be the same as the temperature display of the main controller (when present).

Press button ③ and at the same time set the desired alarm threshold using the potentiometer ④ (set to 200°C in the factory)

The RESM is ready for use.

Start the main controller and check that the temperature displays synchronise.

## 8.5 Functional Check of the RESM

Set the set temperature on the main controller higher than the alarm threshold on the RESM.

Start the RESM.

When the alarm threshold is exceeded the safety contactor must switch off the heatsealing transformer on the primary side.

The ALARM LED ⑥ lights up red.

In the case of an alarm the temperature display moves to an arbitrary end position.

The alarm state remains until the main controller is reset.

( → RESET of RES, → relevant operating manual)

## 8.6 RESM Dimensions

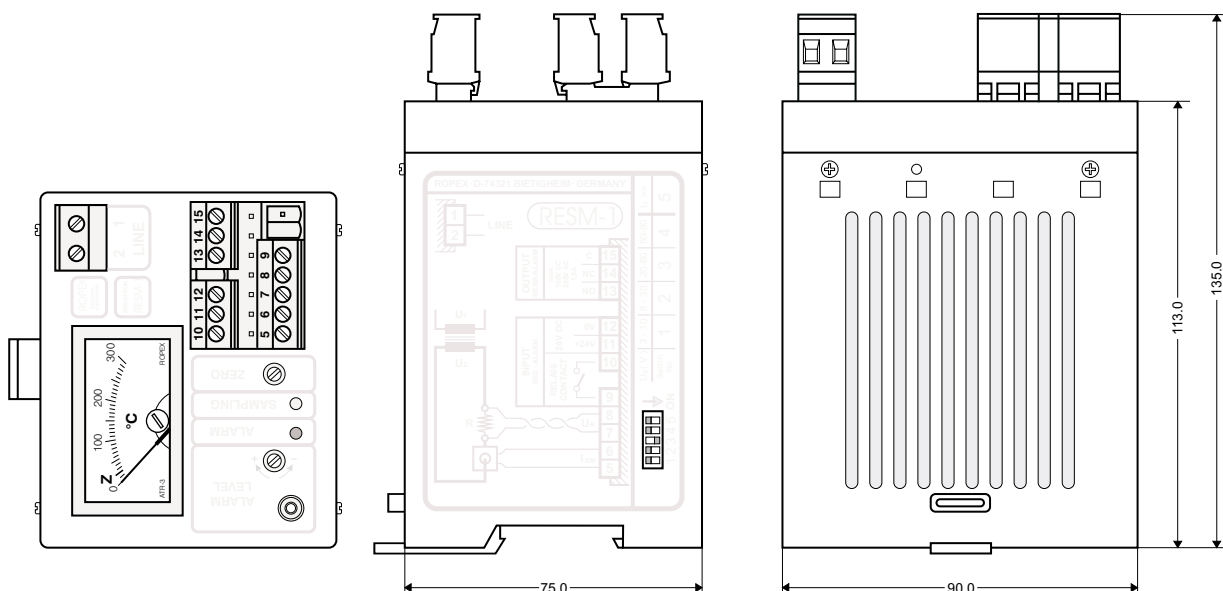

## Current Transformer

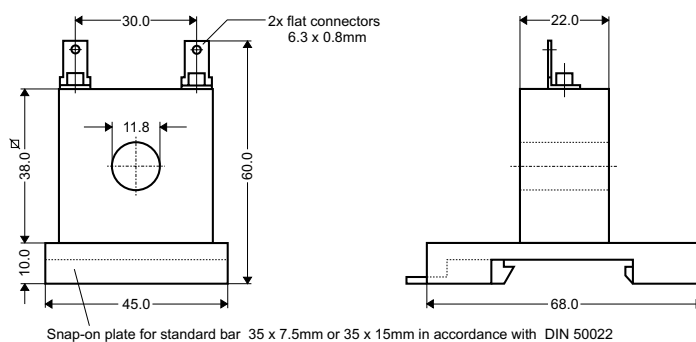

## 9 MONITORING with the MSW and the RESM

In the majority of cases the RESM is used together with the MSW for system monitoring in order to achieve a high degree of safety.

(→ Table 1)

The differentiation in the heatseal layout portrayed in 8.2 and 8.3 also applies here when using both components, i.e. a combination of the circuits in Figure 2 and Figure 3

results (see also the examples). When using both units, all statements made in the description of the individual elements also apply.

The prerequisites stipulated in Section 7 are to be observed.

### 9.1 Functional Check

The functional check of a control system monitored by both units is a combination of the functional checks for each individual unit as described in Sections 8.6 (MSW) and 9.5 (RESM).

The simulation of a fault must in all cases lead to switching off of the load (via the contactor K1).

### 9.2 Examples

#### 9.2.1 Monitoring with the MSW and the RESM with Any Circuit Type

**Without a Danger of Mutual Contact Between the Heatseal Bands**

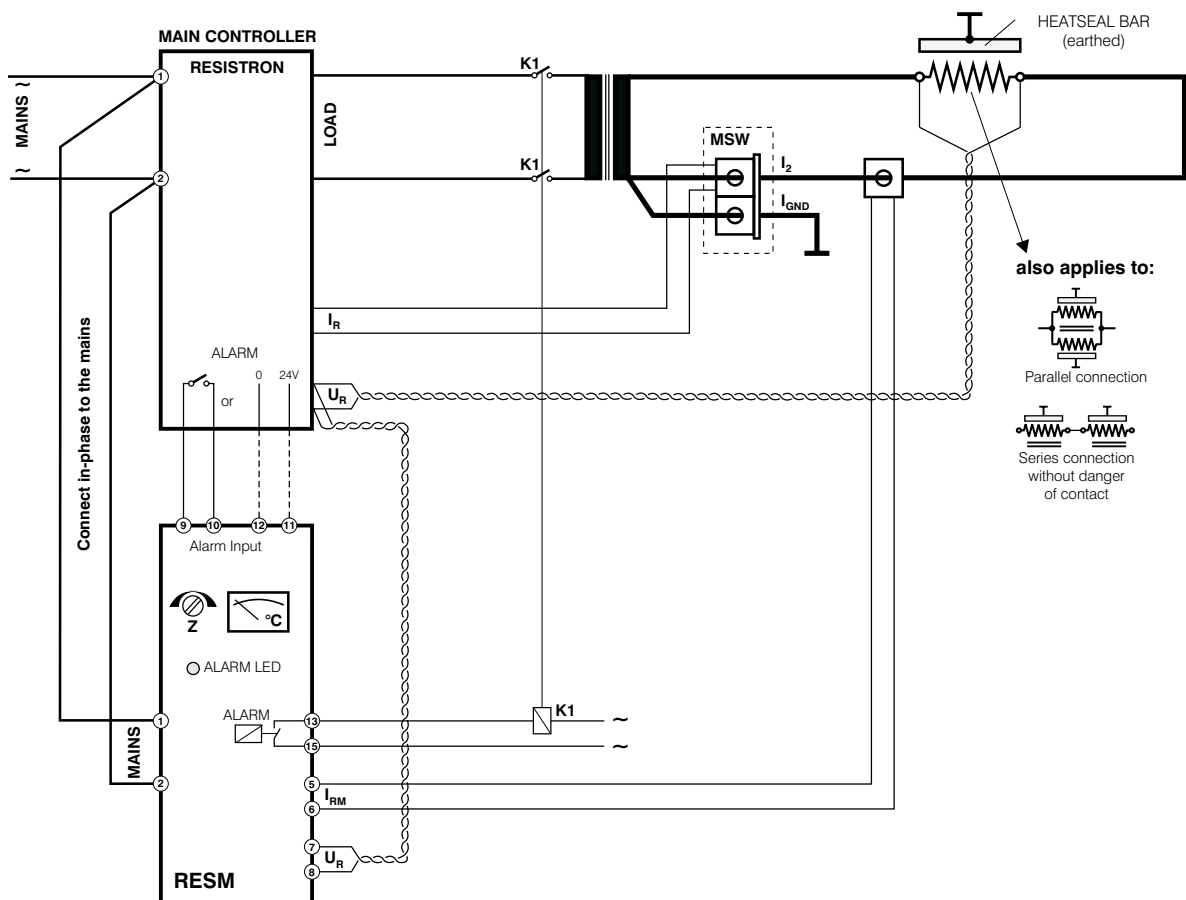

## 9.2.2 Monitoring with the MSW and the RESM with Series Connection With a Danger of Contact Between the Heatseal Bands

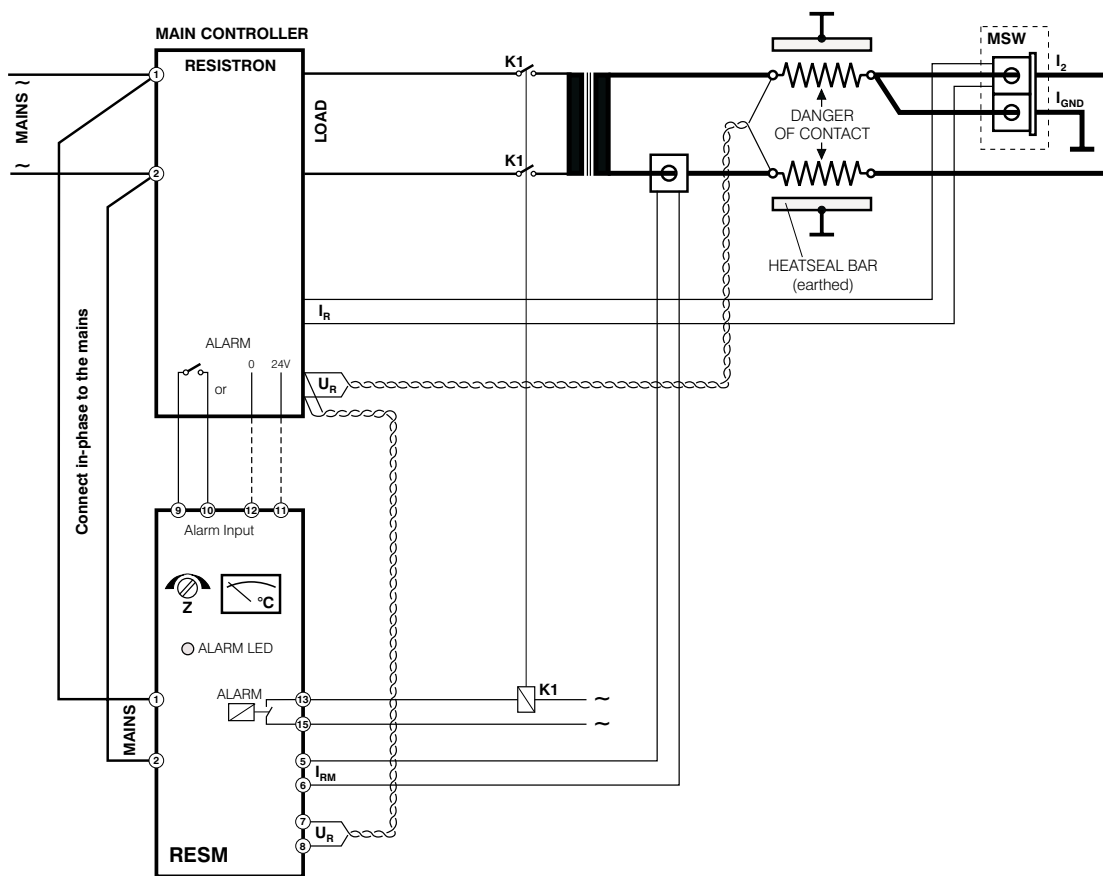

### 10 TYPE IDENTIFICATION (= order text)

- 10.1 MSW - 1**
- Sequential no. for possible variants
  - Monitoring unit **MSW**

**Scope of delivery:** Current transformer block with snap-on plate

### 10.2 RESM - X - X / XXX V - 50/60 Hz

**Mains voltage**  
115VAC, 230VAC, or 400VAC

**Temperature range**  
X = 3  $\hat{=}$  0 - 300°C  
X = 5  $\hat{=}$  0 - 500°C

**Specification main controller**  
X = 1 RESM-1, when main controller is of "series 200"  
X = 4 RESM-4, when main controller is of "series 400"

Monitoring unit **RESM**

**Scope of delivery:** RESM completely with terminal connectors.  
The current transformer PEX-W2 must be ordered seperately.

## 11

## REMAINING RISK

Despite the use of the monitoring units MSW and RESM as previously described, particular operating states are conceivable which can lead to unrecognised overheating of the heatseal band. Some of these have already been described in the previous sections.

Here once again a summary:

- a) **Non-copper-plated heatseal band ends** (see paragraph 7b)
- b) **Heatseal bands with too low or no  $T_k$**  (see paragraph 7c)
- c) **Conductive, non-earthed part** partially bridges the heatseal band during the heating phase

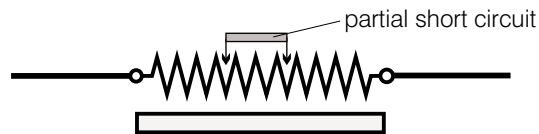

**Consequence:** The controller "sees" a lower resistance and continues to heat to a higher level.

- d) **Reduction of the resistance "seen" by the controller \*)** during the heating phase  
(in principle as above but another reason)

- Example:**
- The terminal for the heatseal band connection has a bad contact (loose contact) (contact resistance)
  - The heatsealing tool is open; the heatseal band is cold; the controller is calibrated to "Z".
  - The tool closes, the controller heats up.
- Under the heatsealing pressure the contact to the heatseal band improves; the resistance reduces; the controller heats to a higher level.

**Generally formulated:** Zero calibration takes place with a high-resistance circuit. The circuit resistance falls during the heating phase.

**Consequence: Overheating**

- e) **Physical damage to the heatseal band** (constriction, crack formation etc.) which leads to a reduction in cross-section  
The heatseal band overheats at this position (HOT SPOT).  
This can even lead to it glowing red-hot.  
The resistance increase which occurs here is so low in relation to the total resistance that it can practically not be recognised by the controller.
- f) **Incorrect operation:** For example: Zero point reduced during the heating phase
- g) **Connection error during the installation** and cabling of the control and monitoring system.  
Remedy: Regular check of the correct operation of the monitoring system by intentional generation of short circuits, interruptions etc. (check list).

\*) The "**resistance seen by the controller**" is the resistance between the two connection points of the voltage measurement lead  $U_R$ .

  <b>INDUSTRIE- ELEKTRONIK</b>	<b>Particularities at the use of RESM- 4 in combination with RES-4XX</b>	Seite: 1 (1)
	<small>L:\Prospekte\Zubehör\MSW-RESM\alt\englisch\RESM-4 Besonderheiten engl.doc</small>	<small>Druck: 18.11.2005</small>

1. The monitoring unit RESM-4 has to be connected like RESM-1 according to the RESM circuit diagrams (see manual „MONITORING UNITS“).
2. At a not yet calibrated RES-4XX the AUTOCAL-command has to be given within 4 seconds after switching on the main voltage. Otherwise the RESM-4 will go into alarm because of missing measuring pulses from the RES-4XX.  
Subsequently the response delay of the measuring pulse monitoring is about 2.3 seconds
3. The heating pulse monitoring of the RESM-4 (as of production date Dec. 05) is activated about 900 ms after switching on the main voltage. A RESM-4 until production date Nov. 05 activates the heating pulse monitoring after about 450 ms.

**RESISTRON temperature controllers with a DIAG-interface (without DIP-switches) shall be used with a RESM-4 as of production date Dec. 05 only. When using an older RESM-4 the faster activation of the heating pulse monitoring might give an alarm when the RESISTRON controller is switched on.**

4. The passing of the RES-4XX alarm signal via the RESM-4 is given without delay.
5. When using controllers with an external RESET-signal (e.g. RES-406, -407, -409 or -445) the RESET-signal shall be activated for 200ms maximum. Otherwise the RESM-4 will go into alarm because of missing measuring pulses from the RES-4XX.
6. At the setting of the RESM-4 alarm level it is to notice, that the shown temperature values of the RES-4XX and RESM-4 can differ up to 10°C, because of the linearization of the RES-4XX temperature characteristic.

Typical differences:

RES-4XX	RESM-4	Difference
20°C	20°C	0
100°C	106°C	+6
150°C	157°C	+7
200°C	205°C	+5
250°C	250°C	0
300°C	293°C	-7